

executive

o3



ALFAOMEGA

collection

executive

03



ALFAOMEGA

collection

codutti

L'ufficio rappresenta la tua identità, il percorso che stai compiendo e i valori che ti accompagnano.

Comfort, tecnologia e funzionalità contribuiscono al tuo benessere e facilitano la riuscita delle attività che ti vedono protagonista nella vita lavorativa.

Noi di Codutti, dal 1954 artigiani e industriali insieme, creiamo soluzioni d'arredo per ufficio di alta gamma con l'attenzione e la cura frutto di oltre sessant'anni di esperienza nella produzione e nel design made in Italy, per le aziende, per gli studi professionali e i progetti contract, anche sui mercati internazionali.

Tutte le nostre collezioni – dagli arredi direzionali agli operativi, dalle sedute alle pareti divisorie – nascono dall'unione di artigianalità e innovazione tecnologica e si contraddistinguono dall'alto livello di qualità e cura del dettaglio propri del marchio Codutti.

La flessibilità per noi è un valore: prendiamo in carico i tuoi progetti e siamo al tuo fianco nel fornire soluzioni personalizzate che superano le tue aspettative.

Un ufficio unico e coinvolgente, che ti emoziona ogni giorno.

Your office shows who you are, what your journey is and your principles are.

Comfort, technology and functionality: all contribute to your wellness and make easier those tasks that see you as the main actor in your daily business life.

We at Codutti have been both craftsmen and industrialists since 1954; we create design solutions for the highline office, paying the attention for the detail we have learned from more than sixty years of experience with the made in Italy production and design.

It's for companies, for professionals and contract projects, also on global markets.

All our collections - from the executive to the operative office, from the chairs to the partition walls - are born from the union between craftsmanship and technology innovation, and stand out thanks to high quality level and care for details, which has always been the main distinction of the Codutti brand.

We believe flexibility is an added value: we take in your project requests and stand at your side to give you customized solutions that go beyond your expectations.

A unique appealing office that excites you day after day.

INDEX

Alfa

01



Glass | White | Carbon

p. 10

03



Glass | White

p. 18

02



Glass | Black | Carbon

p. 14

04



Glass | White | Carbon

p. 22

Omega

05



Ebony | Black | Millemiglia

p. 30

07



Ebony | Black | Coffee

p. 38

09



Walnut | Black

p. 48

06



Walnut | Black | Dove grey

p. 34

08



Walnut | Black | Millemiglia

p. 44

AlfaOmega

design become hi-tech

Dai nostri sogni è nata AlfaOmega, due anime e un tratto curvo che sottende una stessa idea di design.

Alfa è per chi ama un ambiente hi-tech, futurista e innovativo; Omega è per chi preferisce l'eleganza dai canoni classici, bellezza senza tempo.

Dentro AlfaOmega pulsa Soundoffice, un cuore multimediale che dà voce alla scrivania e la trasforma nell'oggetto del desiderio di chi ama la tecnologia e l'eccellenza del miglior made in Italy.

From our dreams comes AlfaOmega, two spirits and a curved section behind the same design idea.

Alfa is for anyone in love with a hi-tech, futurist and innovative interior; Omega is for those who prefer a more classic elegance and timeless beauty.

Inside AlfaOmega beats Sound Office, a multimedia heart that gives voice to the desk and transforms it into an object of desire for technology buffs with all the excellence of the very best of made in Italy.

Alfa

tecnologia e design

L'avanguardia tecnologica si incontra con la ricercatezza e il fascino del design: è Alfa, la declinazione hi-tech di AlfaOmega.

La luce accende dettagli cromati, mentre l'ombra sottolinea morbide curve: piani in vetro ultrachiaro verniciati, curve e sottopiani in laccato lucido, gambe e accessori rivestiti in cuoio materico nelle moderne texture bugnato o carbonio. Bianco e nero: colori decisi per chi vuole sentire in ogni momento l'emozione del controllo.

The technological avantgarde meets with the refinement and charm of the design: it's Alfa, the hi-tech declination of AlfaOmega.

The light highlights chromed details, while shadows underscore soft curves: lacquered extra-clear glass tops, gloss lacquered curves and under-tops, legs and accessories covered in tactile thick leather in modern embossed or carbon textures. White and black: strong colours for those who want to feel the thrill of control at all times.



01 ALFA
GLASS | WHITE | CARBON





A Ante complanari a scorrimento incrociato con sistema di chiusura ammortizzata e illuminazione interna opzionale.
Parallel crossover sliding doors featuring dampened closing system and optional internal lighting.

B Allungo indipendente attrezzabile: può contenere quattro moduli a scelta tra armadietto e coppia cassetti.
Equipped independent extension: can contain a choice of four modules – small cabinet and pair of drawers.

C Il rivestimento in cuoio delle gambe Alfa non richiede l'utilizzo di cuciture; un filo luce cromato supporta i piedini regolabili.
The thick leather upholstery of the Alfa legs does not require the use of stitches; a chrome-plated flush band supports the adjustable feet.

Finiture | Finishes

P. 10 - 11

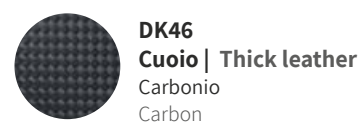
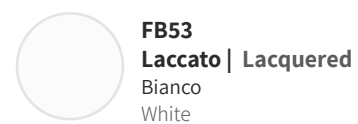
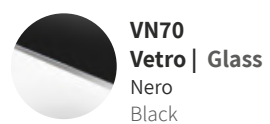

Dati Tecnici | Technical Data

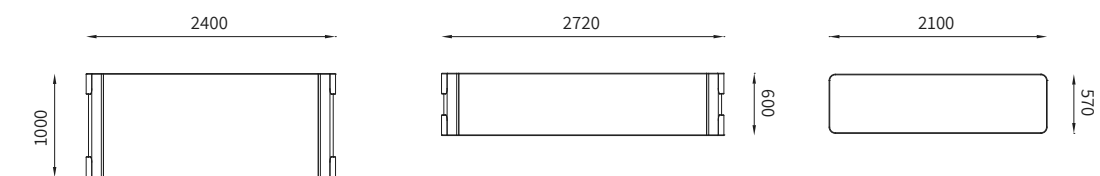

02 ALFA
GLASS | BLACK | CARBON



Finiture | Finishes

P.14 - 15



VN70
Vetro | Glass
Nero
Black



FE52
Laccato | Lacquered
Nero
Black



DK46
Cuoio | Thick leather
Carbonio
Carbon

Dati Tecnici | Technical Data

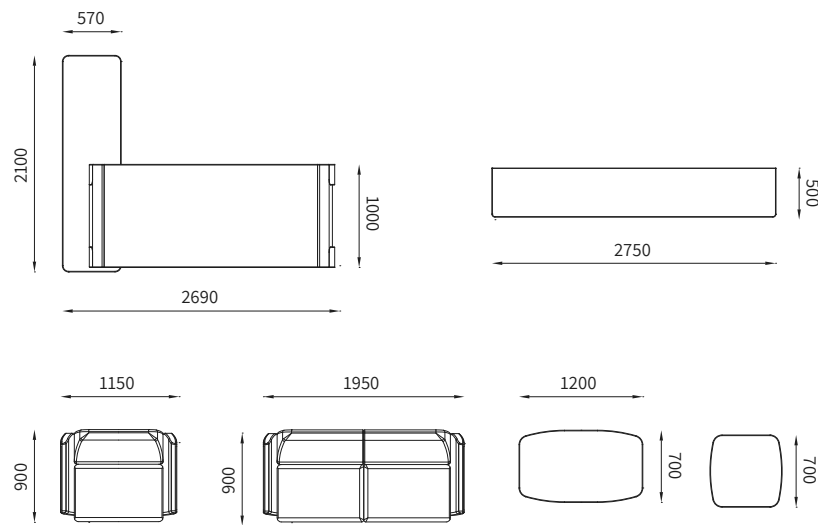

A Incavo e profilo perimetrale possono essere in tinta o in contrasto con il colore di rivestimento della seduta.

Back hollow and profile edge can be in the same or contrasting colour with that of the seat upholstery.

B Design e pelle forata: Coupè si ispira ai sedili delle gloriose auto sportive del passato.

Open work thin leather and design: Coupè is inspired by the glorious sports cars of the past.



È possibile personalizzare la seduta con l'inserimento del logo lavorato a ricamo sullo schienale.

The seats can be personalized by means of the embroidered-finish logo on the back.

03 ALFA
GLASS | WHITE



A I cassetti hanno chiusura soft, il fondo rivestito in cuoio e la serratura opzionale con chiave rivestita in cuoio.

The drawers feature soft closing, the bottoms are covered in thick leather and the optional lock features a leather-covered key.

B Mobiletto attrezzabile: può contenere 2 moduli a scelta tra armadietto e coppia di cassetti.

Extension element that can contain a choice of 2 modules – small cabinet and pair of drawers.

C Sottopiani laccati in finitura lucida bianca o nera.

Under-tops are lacquered in white or black gloss finish.



Dati Tecnici | Technical Data

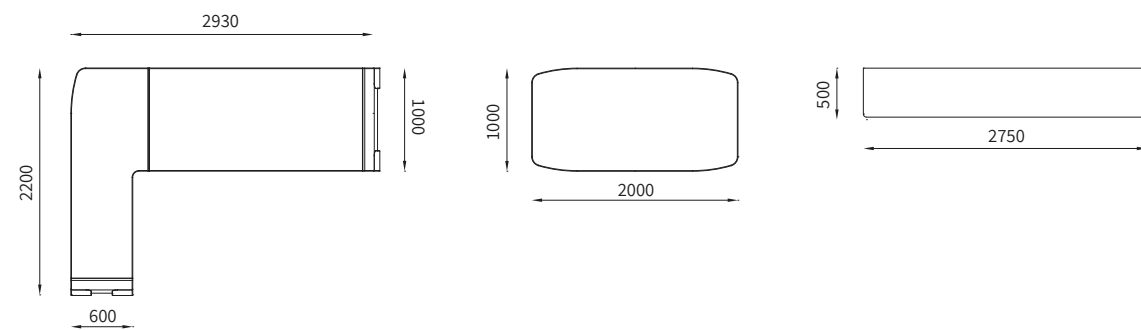

Finiture | Finishes

VB72
Vetro | Glass
Bianco
White

FB53
Laccato | Lacquered
Bianco
White

KB01
Cuoio | Thick leather
Bugnato bianco
White embossed



04 ALFA
GLASS | WHITE | CARBON



Finiture | Finishes

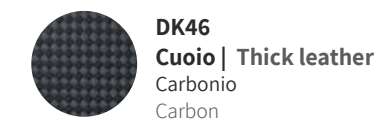
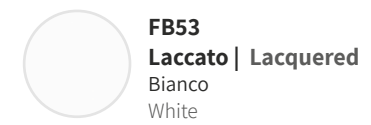
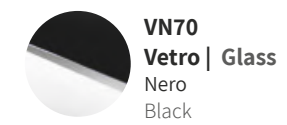

Dati Tecnici | Technical Data

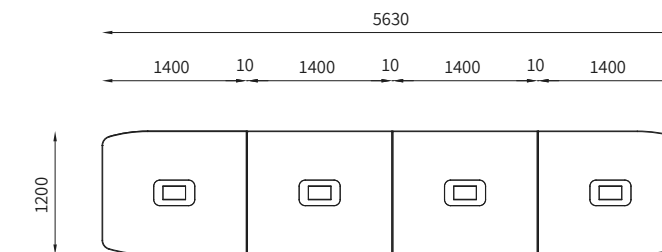

A La forma stondata dello spessore del top è data dall'unione della superficie in vetro con il sottopiano laccato in finitura gloss.

The rounded shape of the top thickness is produced by the union of the glass surface and the gloss-finish lacquered under-top.

B La gamba a colonna è l'unione di due gusci rivestiti in cuoio che lasciano scoperto l'insero laccato.

The column leg is the union of two thick leather-covered shells which leave the lacquered insert uncovered.



Omega

eleganza e raffinatezza

L'attenzione dedicata nel plasmare e accostare i materiali tra loro, crea quell'atmosfera elegante e di pregio che solo Omega può regalare. Lo si intuisce dall'impegno nella selezione delle essenze di legno, rovere tinto ebano e tinto noce, le cui venature si intrecciano in piani e curve; dal raffinato inserimento del vetro nero; dall'utilizzo di cuoi esclusivi come il vinaccia e il millemiglia.

The attention dedicated to shaping and combining materials together, creates an elegant and prestigious atmosphere that only Omega can offer. This can be seen from the care in the selection of woods, ebony and walnut dyed oak, the grains of which intertwine in tops and curves; in the refined insertion of black glass; in the use of exclusive thick leathers such as plum red colour and millemiglia.



05 OMEGA
EBONY | BLACK | MILLEMIGLIA







A Le gambe Omega sono rivestite in cuoio cucito a mano nel caratteristico punto sella.
The Omega legs are covered in thick leather, saddle-stitched by hand.

B Le curve di raccordo si distinguono dal top per l'incrocio delle venature del legno.
What makes the connection curves different from the top are the crossover wood grains.

Finiture | Finishes

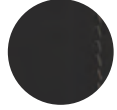
 SH11 Legno Wood Rovere tinto ebano Ebony dyed oak	 FE52 Laccato Lacquered Nero Black	 DM45 Cuoio Thick leather Millemiglia Millemiglia
---------------------------------------------------------------------------------------------------------------------------------------------------------------------	-----------------------------------------------------------------------------------------------------------------------------------------------------	--------------------------------------------------------------------------------------------------------------------------------------------------------------------

Dati Tecnici | Technical Data

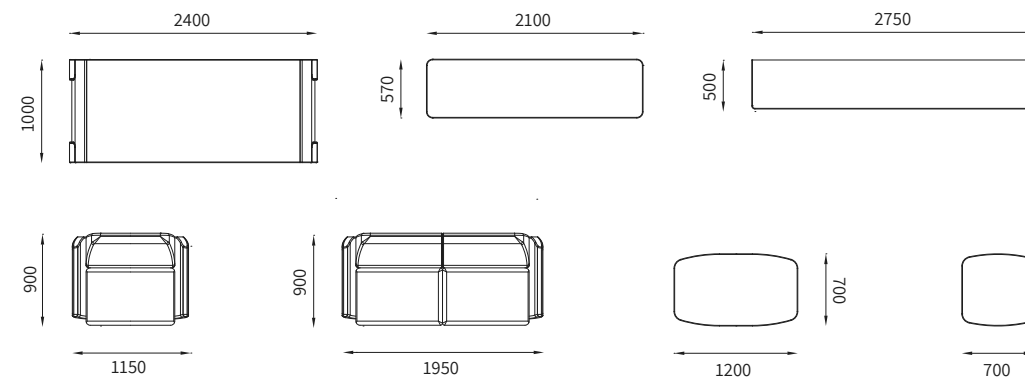

06 OMEGA
WALNUT | BLACK | DOVE GREY



Piccole, anatomiche, preziose: queste sono le maniglie AlfaOmega in acciaio cromato.

Small, anatomic, precious: these are the AlfaOmega handles in chrome-plated steel.

Finiture | Finishes



SU09
Legno | Wood
Rovere tinto noce
Walnut dyed oak



FE52
Laccato | Lacquered
Nero
Black



CT86
Cuoio | Thick leather
Tortora
Dove grey

Dati Tecnici | Technical Data

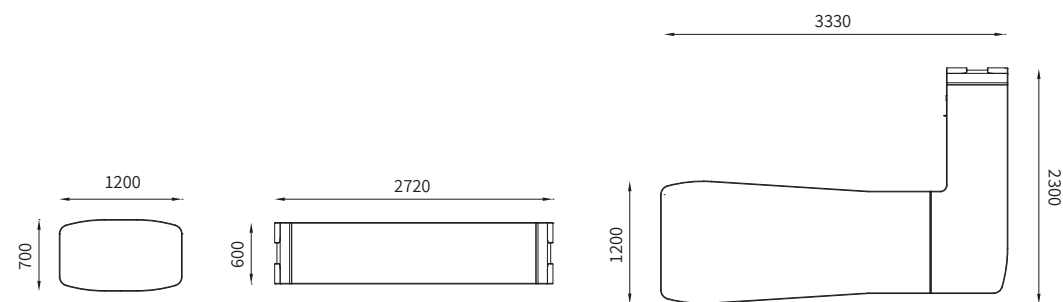

07 OMEGA
EBONY | BLACK | COFFEE





Tavoli riunione di forme, dimensioni e finiture personalizzate: l'ufficio tecnico Codutti è a disposizione per realizzare le vostre idee.

Meeting tables with personalized shapes, dimensions and finishes: the Codutti technical department is at disposal to put your idea into practice.



Fascia tecnica centrale in cuoio con sportellini bilaterali per la fuoriuscita dei cavi.

Central thick leather band with bilateral doors for the cables to come out.

Dati Tecnici | Technical Data

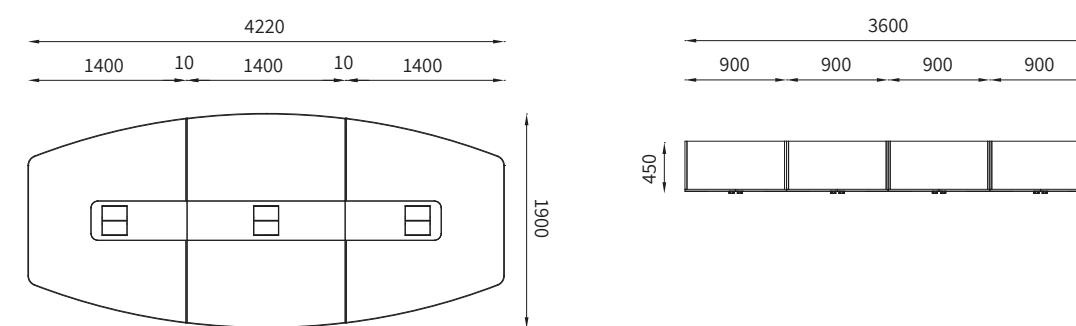

Finiture | Finishes

SH11
Legno | Wood
Rovere tinto ebano
Ebony dyed oak

FE52
Laccato | Lacquered
Black
Nero

CL84
Cuoio | Thick leather
Caffè
Coffee



A Le cuciture a punto sella sono il risultato della maestria dei nostri artigiani che eseguono le lavorazioni manualmente.

The saddle stitching is the upshot of the skill of our craftsmen and is all handmade.

B Tavolo componibile: i moduli del piano sono separati da un filo luce in acciaio cromato.

Modular table: the top modules are separated by a chrome-plated flush band.



08 OMEGA
WALNUT | BLACK | MILLEMIGLIA



Dati Tecnici | Technical Data

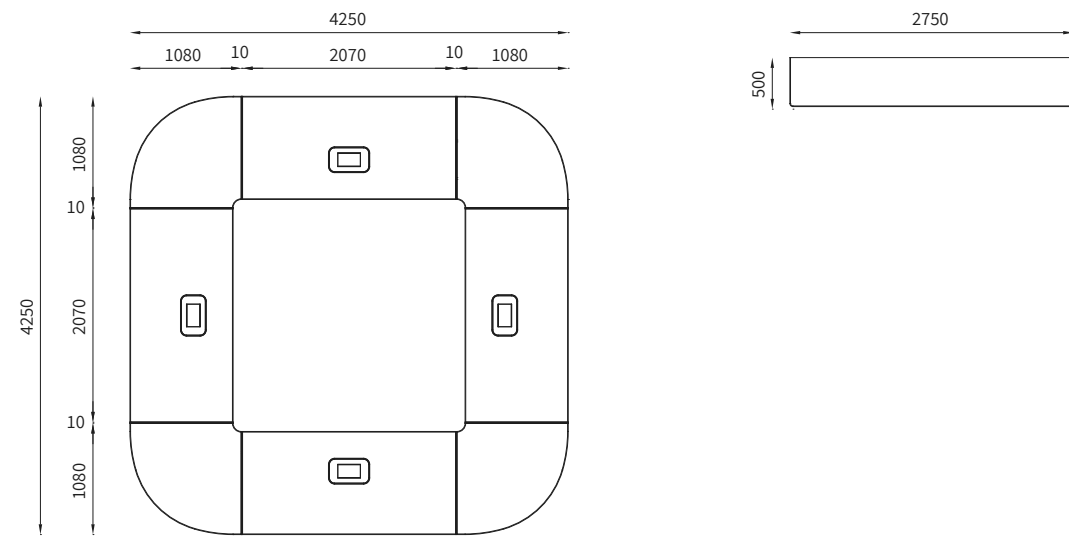

A L'alzamonitor consente di alzare, abbassare, ruotare in avanti e indietro gli schermi. Il controllo può essere manuale, remoto o centralizzato.

The screen lifting mechanism permits raising, lowering and turning the screens backwards and forwards. Control is manual, remote or centralized.

B Elemento di testa per tavolo riunione componibile in conformazione a "U".

Head element for modular U-shaped meeting table.



C All'interno degli sportellini possono essere collocate apposite prese multifunzione.

Special multifunction sockets can be placed inside the doors.

Finiture | Finishes

P. 44 - 45

SU09
Legno | Wood
Rovere tinto noce
Walnut dyed oak

FE52
Laccato | Lacquered
Nero
Black

DM45
Cuoio | Thick leather
Millemiglia
Millemiglia

09 OMEGA
WALNUT | BLACK





Dati Tecnici | Technical Data

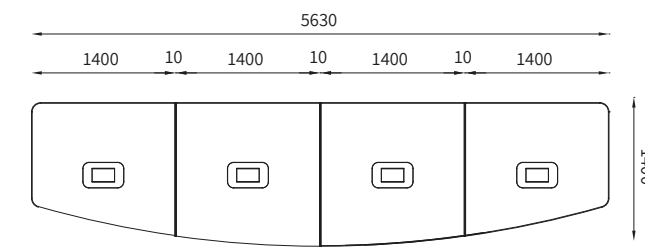

A Le giunzioni fra i top dei tavoli sono impreziosite da un filolucente cromato.
 Joints between table tops are enhanced with a chrome-plated band in steel.

B I tavoli semiovali presentano uno schienale a tutta altezza in legno verniciato nelle stesse finiture dei top.
 Semi-oval tables have a full-length back panel in wood stained the same colour as the tops.

C Le gambe sono rivestite in cuoio e sono impreziosite da un filolucente cromato.
 Leather-covered legs are enhanced with a chrome-plated flush band.

Finiture | Finishes

SU09
Legno | Wood
 Rovere tinto noce
 Walnut dyed oak

FE52
Laccato | Lacquered
 Nero
 Black

CN72
Cuoio | Thick leather
 Nero
 Black



CHOOSE YOUR MUSIC

CODUTTI SOUND OFFICE the hi-fi writing desk

Musica e design si incontrano in un'armonia unica.
Dal cuore vibrante della scrivania una magica atmosfera invade l'ambiente.

Music and design meet in a unique harmony.
From the vibrant heart of the desk a magical atmosphere invades the environment.

Scrivania o cabina di regia? Writing desk or control room?

Lavorare telefonando senza il dispositivo in mano o rilassarsi ascoltando musica in Hi-Fi? Tutto questo è Soundoffice.

Working on the phone without having to hold it in your hand or relaxing while listening to Hi-Fi music? All this is Soundoffice.



Scrivania o cassa armonica? Writing desk or soundbox?



A Controlli | Controls

Una gestione facile ed intuitiva dei comandi consente la regolazione del volume, la risposta alle chiamate in arrivo e l'interazione di Soundoffice con i dispositivi multimediali. Questi ultimi si possono connettere alla scrivania attraverso il cavo Audio Mini-Jack o attraverso il protocollo di comunicazione senza fili Bluetooth.

Easy-to-adjust and intuitive controls for regulating volume, incoming call answering and Soundoffice interaction with multi-media devices. The latter can be connected to the writing desk by means of the Audio Mini-Jack lead or through the communication protocol without Bluetooth wires.

Microfono | Microphone

On / Off

Chiamata | Call

Volume - / Volume +

Ø 3.5 mm audio mini-jack

Bluetooth

B Casse acustiche | Loudspeakers

Il suono ricco e dettagliato sembra provenire dalle pareti, dal soffitto, dal pavimento, pervade l'ambiente e rapisce con sonorità coinvolgenti. I diffusori, che alloggiato sotto al piano, si trovano nella posizione ottimale per l'ascolto da parte di chi siede alla scrivania.

- Casse acustiche con potenza nominale di 20W a 8 ohm e risposta di 95-22.000 Hz
- Amplificatore stereo hi-fi con frequenze tra i 20 e 20.000Hz

The rich and detailed sound seems to come from the walls, the ceiling, the floor and pervades the environment and enraptures with fascinating sound effects. The speakers, housed under the top, are perfectly positioned for listening by anyone sat at the desk.

- Loudspeakers with 20W nominal power at 8 ohm and 95 - 22.000 Hz response.
- Stereo hi-fi amplifier with frequency between 20 and 20.000Hz.

C Canalizzazione | Ducting

I cavi che alimentano Soundoffice transitano dal vano di diffusione alla canalizzazione posta tra le due traverse, per poi scendere a terra attraverso un elegante contenitore accoppiato alla gamba della scrivania, rivestito in cuoio o nell'esclusiva pietra.

The Soundoffice power leads transit from the speaker compartment to the ducts located between the two crosspieces, then they run down to the floor through an elegant container placed on a leg of the writing desk and covered in leather or exclusive stone.

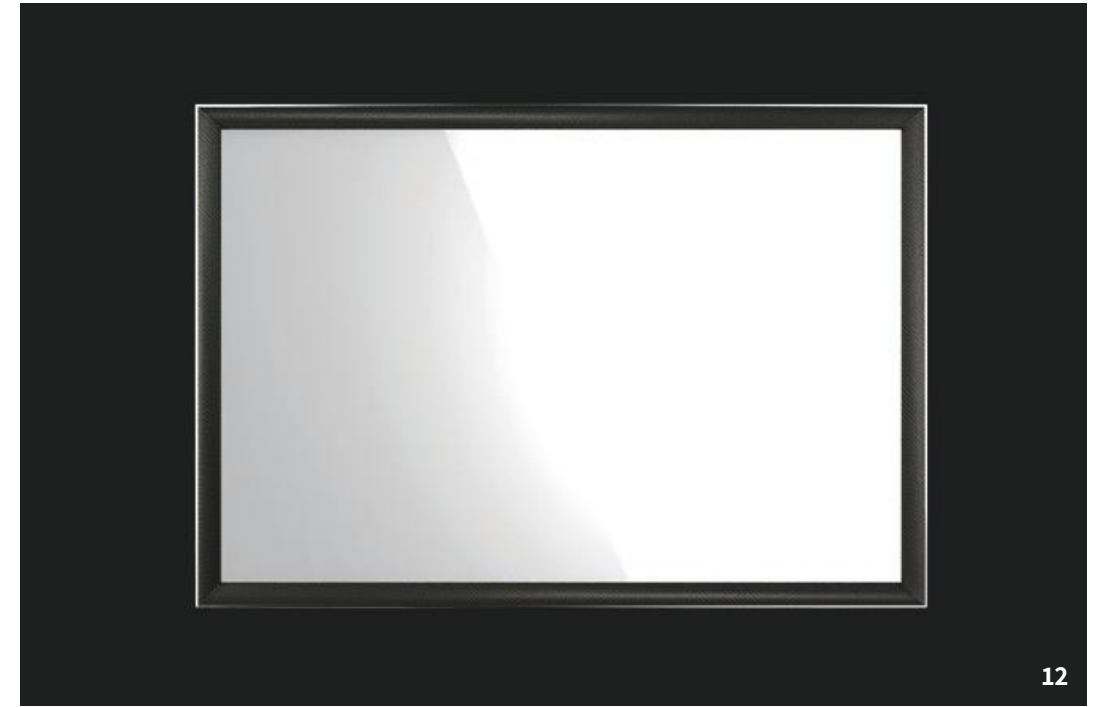
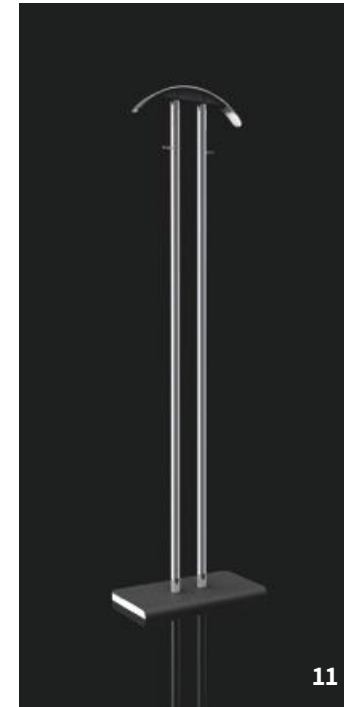
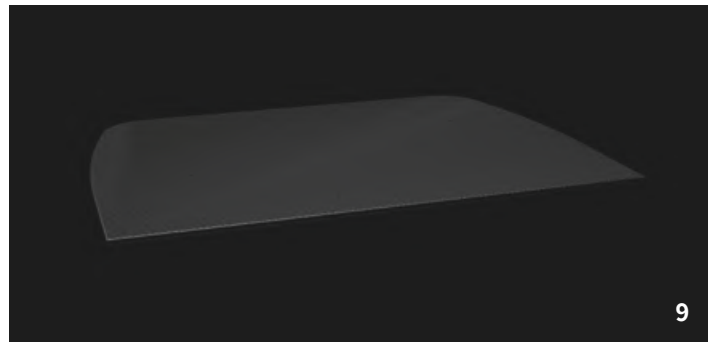
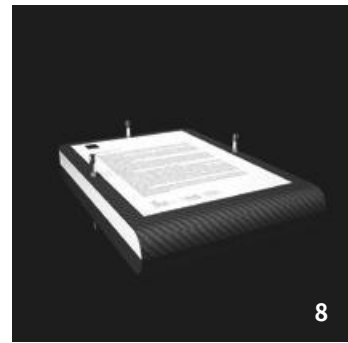
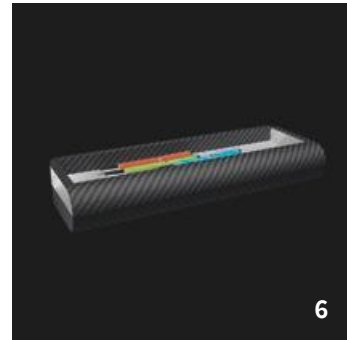
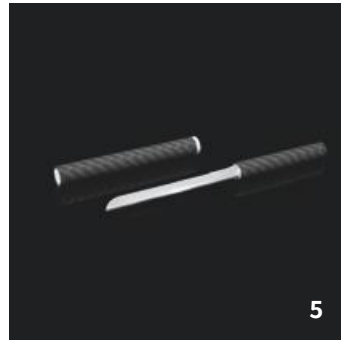
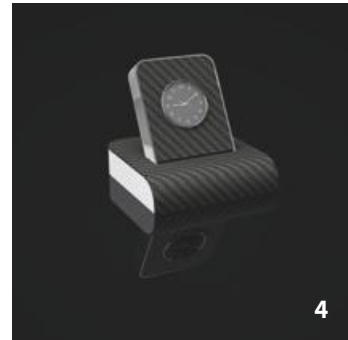
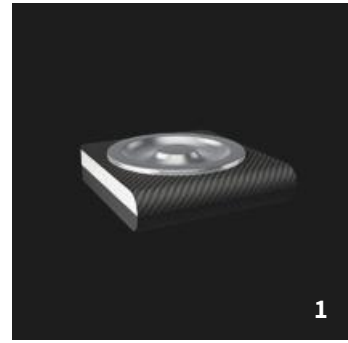

1 Posacenere
Ashtray

2 Cestino
Wastepaper basket

3 Portabiglietti
Cards holder

4 Orologio
Clock

5 Tagliacarte
Paper knife

6 Portapenne
Pen holder

7 Lampada da terra
Floor lamp

8 Portacarte
Paper tray

9 Sottomano in cuoio
Desk pad covered in leather

10 Lampada da tavolo
Desk lamp

11 Appendiabiti
Coat stand

12 Specchio
Mirror

13 Lampada da tavolo
Desk lamp

14 Cassaforte
Built-in safe

15 Frigorifero
Built-in refrigerator

16 Portafoto
Photo frame

Rainbow

I colori ed i loro abbinamenti esprimono chi sei. Poterli scegliere significa trovare la libertà di esprimersi e l'occasione di trasmettere un messaggio a chi ti circonda. Rainbow è il progetto che permette di personalizzare il colore di ogni collezione scegliendo tra le numerose finiture di cuoio previste nel Campionario Finiture Codutti.

The colours and the way they are matched tell who you are. Being able to choose them means having the freedom to express yourself and the chance to send a message to those around you. Rainbow is the project which permits personalizing the colour of every collection, choosing from among the numerous leather finishes in the Codutti Sample Book.



ALFA

OMEGA

Cuoio | Leather

DK46
Carbonio | Carbon

KB01
Bugnato bianco | White embossed

KE02
Bugnato nero | Black embossed

FB53
Bianco | White

FE52
Nero | Black

VB72
Bianco | White

VN70
Nero | Black

Laccato | Lacquered

Vetro | Glass

Legno | Wood

SU09
Rovere tinto noce | Walnut dyed oak

SH11
Rovere tinto ebano | Ebony dyed oak

QA51
Pietra Ardesia | Ardesia stone

DM45
Millemgia | Millemgia

CI71
Vinaccia | Plum red

FE52
Nero | Black

VN70
Nero | Black

Laccato | Lacquered

Vetro | Glass

Il legno presente nelle collezioni direzionali Codutti è un materiale naturale. Per questo motivo differenze nelle caratteristiche cromatiche e di venatura presenti in ogni singolo elemento d'arredo, sono considerati segni distintivi di pregio. Il cuoio e la pelle sono materiali diversamente trattati, quindi diversa è la rifrazione della luce che determina il tono del colore. Le cuciture di pelle e cuoio possono presentare irregolarità nel tratto e variazioni di linea. Pertanto differenze di tono del colore e lievi imperfezioni nelle cuciture devono essere accettate quale segno dell'unicità e della cura artigianale del prodotto. Codutti Furniture S.r.l. si riserva di apportare qualsiasi modifica alle Collezioni presenti in questo catalogo ogni volta che lo ritenga opportuno.

The wood in Codutti's executive collections is natural material. Any differences in terms of color and veining between individual pieces of furniture are therefore considered as characteristic and distinctive markings. Thick leather and thin leather undergo different curing processes. As a result, the surfaces refract light differently and this determines a variation in the shade of the color. Moreover, the stitching in both thick and thin leather may appear irregular. Any differences in the shade of color and slight imperfections in the stitching are the natural consequence of the craftsmanship involved in the manufacturing process, which makes each product unique. Codutti Furniture S.r.l. is entitled to bring any modifications on Collections included in this catalogue at any time, without previous notice.

SCRIVANIE E ALLUNGHI | DESKS AND EXTENSIONS

Top legno | Wood top

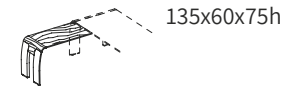
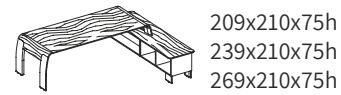
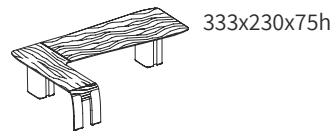
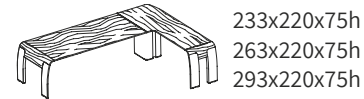
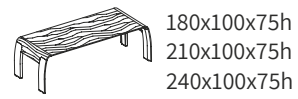

Top vetro | Glass top

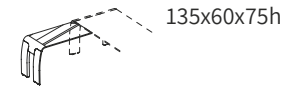
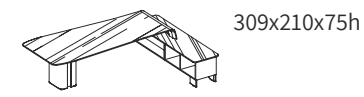
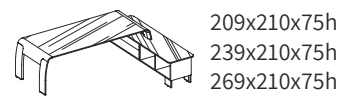
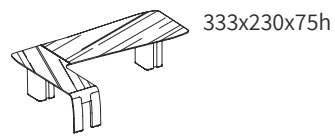
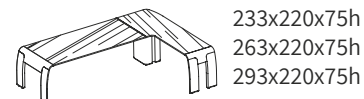
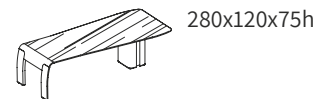
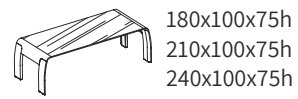

LIBRERIE | BOOKCASES

Top legno | Wood top

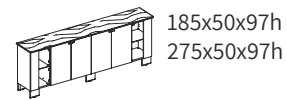

Top vetro | Glass top

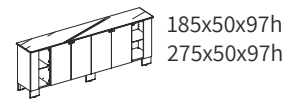

CASSETTIERE | DRAWER UNITS



TAVOLINI ATTESA | SIDE TABLES

Top vetro | Glass top

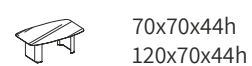

Top legno | Wood top

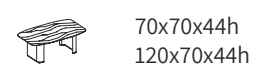

TAVOLI RIUNIONE | MEETING TABLES

Top legno | Wood top

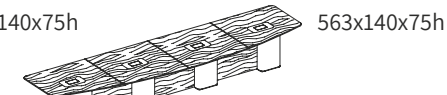
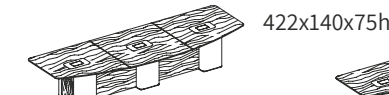
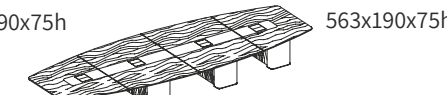
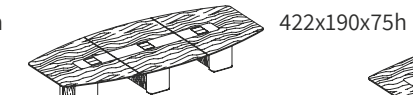
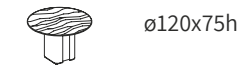

Top vetro | Glass top

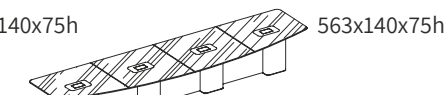
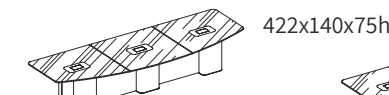
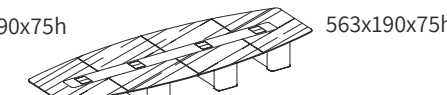
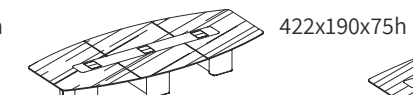
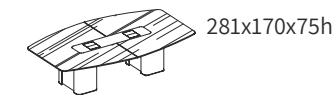
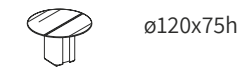

ARMADI | CABINETS



PULPITO | PULPIT

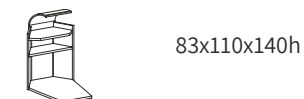

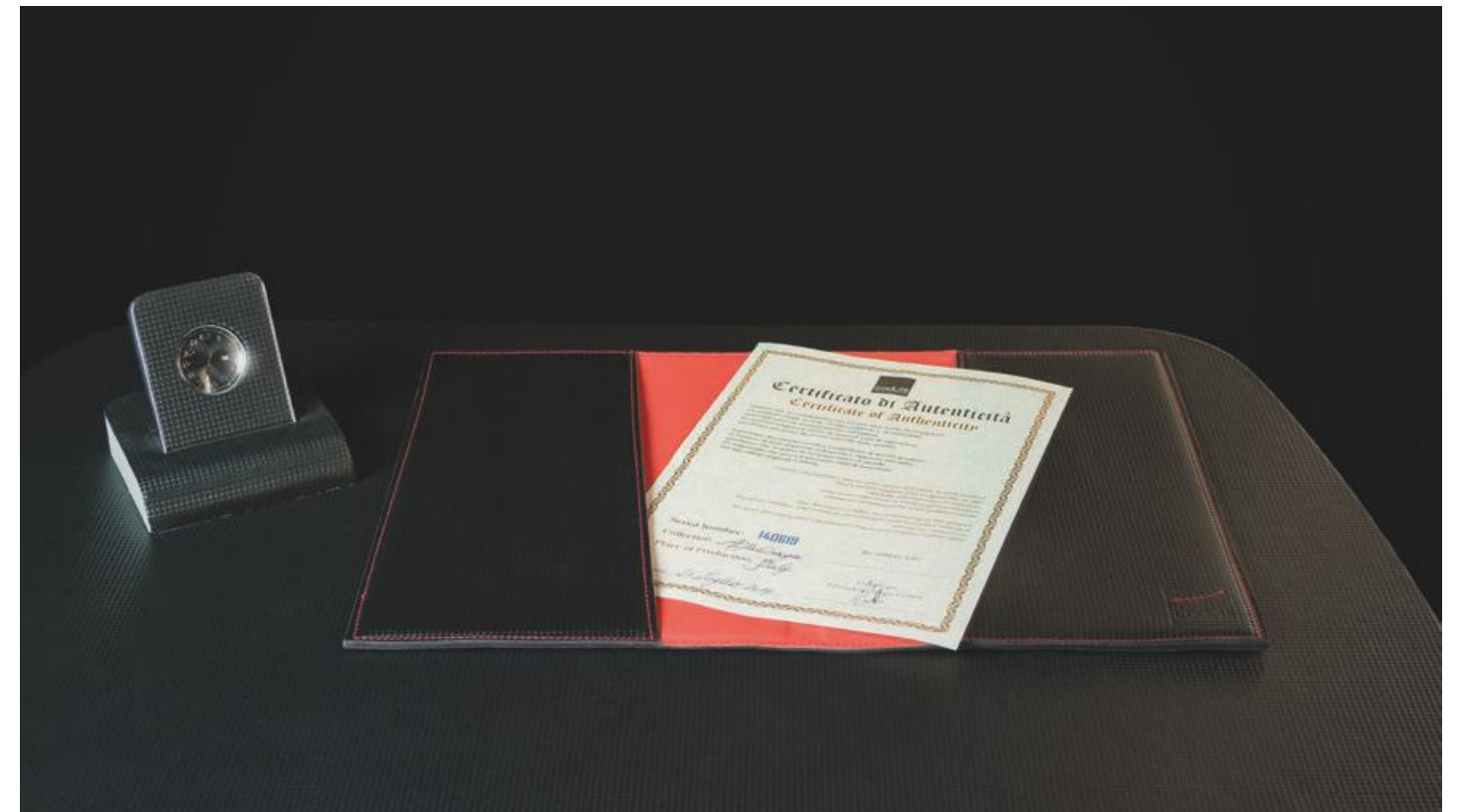

Le lavorazioni eseguite in modo magistrale dai nostri artigiani e il numero di serie, fanno di ogni scrivania e tavolo riunione AlfaOmega un pezzo unico al mondo. Per i clienti che scelgono questa collezione abbiamo creato lo Scrigno di AlfaOmega, un cofanetto che contiene il kit di pulizia e di ritocco per mantenere inalterata nel tempo la bellezza dei nostri arredi. Nel cofanetto, un nostro regalo: il portadocumenti in cuoio realizzato a mano che contiene il Certificato di Autenticità del vostro ufficio AlfaOmega.

The finishes created by the skilful hands of our craftsmen and the serial number, ensure that each AlfaOmega writing desk and meeting table is truly one of a kind in the world. For the customers who choose this collection, we have created the AlfaOmega Treasure Chest, a casket containing a cleaning and touch-up kit to keep our furnishings looking beautiful over the years. Inside the casket, a gift from us, you will find a handmade leather document holder containing the Certificate of Authenticity of your AlfaOmega office.

Rendered by

Cesare Bellafronte
Andrea Macor Rendering
Alberto Codognotto | Kodocreation

Print

Treviso Stampa

Copyright© 2018
by Codutti Furniture S.r.l.



executive

ALFAOMEGA

collection

UDINE
ROME
LONDON
SHANGHAI
PANAMA
MOSCOW
MUMBAI
CHILE

